

# TOSHIBA

## INSTRUCTION MANUAL

### CCD CAMERA

# IK-542XD

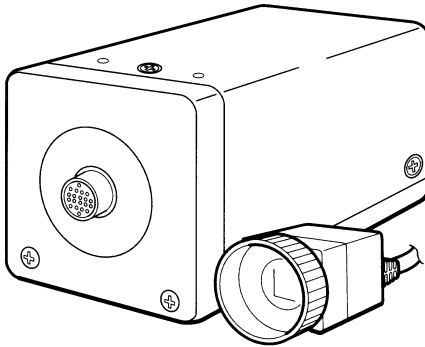

#### For Customer Use

Enter below the Serial No. which is located on the bottom of the cabinet. Retain this information for future reference.

Model No.: IK-542XD \_\_\_\_\_

Serial No.: \_\_\_\_\_

#### WARNING

This is a Class A of EN55022 product. In a domestic environment this product may cause radio interference in which case the user may be required to take adequate measures.

#### FCC STATEMENT

This device complies with Part 15 of FCC Rules. Operation is subject to the following two conditions: (1) This device may not cause harmful interference, and (2) this device must accept any interference received, including interference that may cause undesired operation.

#### INFORMATION

This equipment has been tested and found to comply with the limits for a Class A digital device, pursuant to Part 15 of the FCC Rules. These limits are designed to provide reasonable protection against harmful interference when the equipment is operated in a commercial environment. This equipment generates, uses, and can radiate radio frequency energy and, if not installed and used in accordance with the instruction manual, may cause harmful interference to radio communications. Operation of this equipment in a residential area is likely to cause harmful interference in which case the user will be required to correct the interference at his own expense.

**USER-INSTALLER CAUTION:** Your authority to operate this FCC verified equipment could be voided if you make changes or modifications not expressly approved by the party responsible for compliance to Part 15 of the FCC rules.

This Class A digital apparatus complies with Canadian ICES-003.

Cet appareil numérique de la classe A est conforme à la norme NMB-003 du Canada.

# TABLE OF CONTENTS

1. COMPONENTS .....	3
2. FEATURES .....	3
3. SPECIFICATIONS .....	4
4. NAMES AND FUNCTIONS, EXTERNAL SIZE .....	5
4.1 Camera Head .....	5
4.2 Camera Controller .....	6
5. CONNECTION .....	8
5.1 When Using AC Adapter .....	8
5.2 When Using 12 Pin Connector .....	8
6. I/O SIGNALS .....	9
6.1 External Sync Signal .....	9
6.2 Trigger Input .....	9
6.3 12 Pin Connector DC IN/SYNC Terminal .....	10
7. ELECTRONIC SHUTTER SETTING METHOD .....	11
8. VIDEO OUTPUT IN NORMAL MODE .....	11
9. VIDEO OUTPUT IN 1-PULSE TRIGGER MODE (For setting, refer to page 18.) .....	12
9.1 1-Pulse Trigger SYNC Reset Mode .....	12
9.2 1-Pulse Trigger SYNC Non Reset Mode .....	13
9.3 1-Pulse Trigger TRIG ~ EXT. VD Exposure Mode .....	14
10. VIDEO OUTPUT IN 2-PULSE TRIGGER MODE (For setting, refer to page 18.) .....	15
10.1 2-Pulse Trigger SYNC Reset Mode .....	15
10.2 2-Pulse Trigger SYNC Non Reset Mode .....	16
11. FREEZE MODE .....	17
12. LOCATION AND FUNCTION OF INTERNAL SWITCHES .....	17
13. GAIN SWITCH .....	18
14. CHANGING HEAD CABLE ORIENTATION .....	22
15. CAUTIONS ON USE AND INSTALLATION .....	24
16. BEFORE MAKING A SERVICE CALL .....	24

# 1. COMPONENTS

(1) Camera head .....	1
(2) Camera control unit .....	1
(3) C-mount ring .....	1
(4) Instruction manual .....	1
(5) Warranty card .....	1

# 2. FEATURES

Full frame shutter camera utilizing a square pixel format.

- (1) Square pixel array with a VGA format (progressive scan) CCD employed.  
The square pixel format and progressive scan image output make this camera well suited for the computer environment.
- (2) Frame shutter  
Ability to capture entire images in one exposure. This effectively doubles the vertical resolution of the camera.
- (3) Odd/Even signals output at the same time.  
Full frames can be output in 1/60 second, twice as fast as conventional cameras.
- (4) Applicable to EIA standard output by memory as standard equipment.  
Since the field memory is standard equipment, the unit is applicable to EIA standard output. This allows you to use the picture processing devices and monitor, etc. that you presently use. (The exposure interval is 1/30 second.)
- (5) 1-pulse trigger mode  
With the 1-pulse trigger mode exposure can be activated by a single pulse at asynchronous intervals.
- (6) 2-pulse trigger mode  
The exposure time is determined by the width of 2 pulse with the 2-pulse trigger mode, also this is available on a long exposure time over 1/60 second.
- (7) Electrical shutter speeds  
15 Shutter speeds are available allowing exposure time to be set in discrete intervals.
- (8) Small sized camera head of 26mm(W) x 22mm(H) x 30mm(D) allows installation in a very small space.
- (9) C-mount lens  
A C-mount ring is supplied so that widely available C-mount lenses may be used.
- (10) Gold plated 12 pin connector  
Power, outputs and inputs are available on one convenient connector to allow complete wiring with only one cable.

### 3. SPECIFICATIONS

Power supply	DC12V $\pm$ 10%
Power consumption	4.3W
Image element	1/2 inch, interline transfer CCD
Effective pixels	H: 659 pixels, V: 494 pixels
Effective shooting area	H: 6.52mm, V: 4.89mm (1/2" type)
Scanning system	2:1 interlaced, non interlaced modes
Scan frequency	Horizontal: 15.734 kHz, Vertical: 59.94 Hz
Sync system	Internal/External (automatic switching) • HD, VD mode
Trigger function	1-pulse / 2-pulse trigger mode • sync reset mode • sync non reset mode • TRIG ~ EXT. VD mode (Only at 1-pulse trigger mode)
Resolution	H: 490 TV lines, V: more than 480 TV lines
Normal illumination	400 lx (F4 gamma=0.45, gain SW: off)
Min. illumination	3 lx (F1.4, gamma=0.45, gain SW: on, gain max.)
S/N ratio	More than 56 dB (gamma=1.0. weighting filter ON)
Video output	1.0 V(p-p), based on EIA system
Output impedance	75 $\Omega$ unbalanced
Lens mount	M19 (P=0.5) (C-mount conversion ring supplied)
Ambient operating temperature/humidity	-10 ~ $\pm$ 50°C / less than 90% relative humidity
Anti-vibration and shock	Anti-vibration 70m/s <sup>2</sup> (10 ~ 200Hz), Anti-shock 700m/s <sup>2</sup>
Weight	Camera head: about 25g (without cable) Camera controller: about 160g
Camera cable	Directly extended from head side Length: 0.5m, Diameter: 5mm
Dimensions	Camera head: 26 (W) x 22 (H) x 30 (D) mm (protrusion not included) Camera controller: 44 (W) x 44 (H) x 77.5 (D) mm (protrusion not included)
Gain switch	OFF (0 dB) / ON (0 ~ +9 dB) internal GAIN VR available
Electronic shutter	1/30s, 1/60s, 1/100s, 1/125s, 1/250s, 1/500s, 1/1000s, 1/1500s, 1/2000s, 1/3000s, 1/4000s, 1/6000s, 1/8000s, 1/10000s, 1/30000s, 1/50000s
Video output switch	1/30I output: EIA standard output (1/30s) 1/60N output: 2 lines parallel output (1/60s) 1/30N output: 1 line sequential output (1/30s)
Applicable regulations	CE, FCC Class A, VCCI Class A based
Others	Video index output, image output (DC coupled)
Option accessories	Extension cable (EXC-7X01: 1.5m), (EXC-7X03: 3m)

# 4. NAMES AND FUNCTIONS, EXTERNAL SIZE

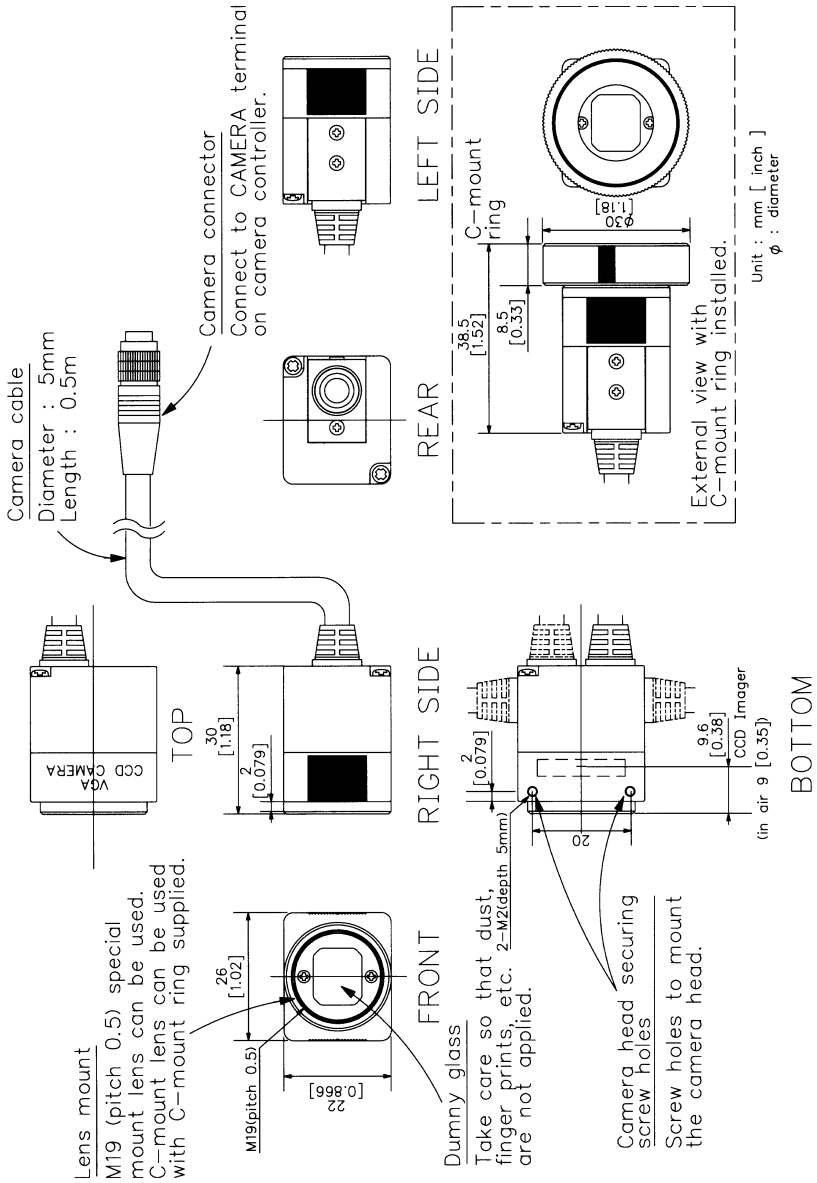

# 4.2 Camera Controller

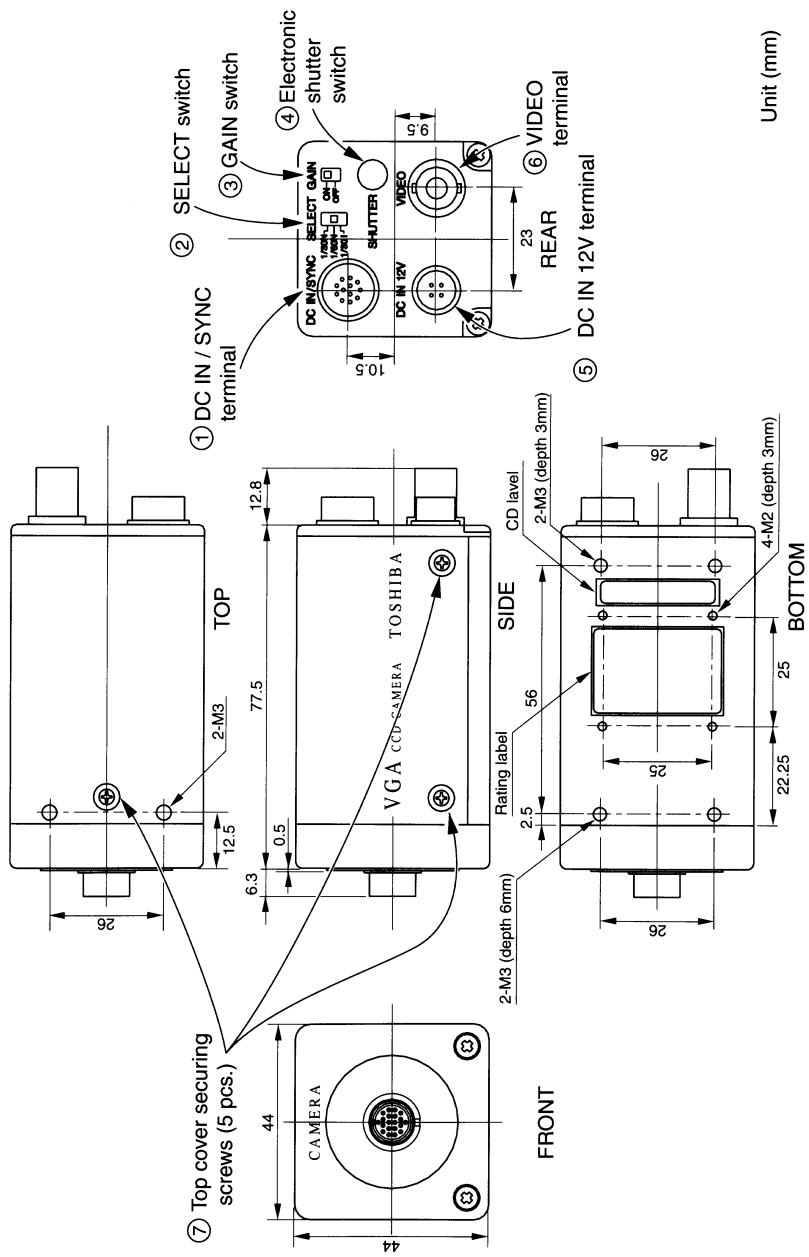

Unit (mm)

① **DC IN/SYNC terminal (For detail, refer to page 10.)**

Used when performing the external sync and trigger function. Also used for power supply and video output.

② **SELECT switch**

Switches the camera video output system.

<b>SELECT</b>	<b>Video output system</b>
1/30N	1/30 second non-interlace mode (line sequential output)
1/60N	1/60 second non-interlace mode (ODD/EVEN simultaneous output)
1/30I	1/30 second interlace mode (output of EIA standard.)

③ **GAIN switch**

Switches the camera sensitivity.

<b>GAIN</b>	<b>Sensitivity</b>	<b>Remarks</b>
ON	0~9dB	Adjustable with the volume inside the camera controller.
OFF	0dB	Normally set to this position.

④ **Electronic shutter switch**

Performs setting of the standard mode and shutter speed (exposure time) at 1 pulse trigger mode, and switching into 2-pulse trigger mode.

⑤ **DC IN 12V terminal**

Used as a DC 12V input terminal.

⑥ **VIDEO terminal**

Develops video signal (VIDEO 1).

**Important**

The VIDEO1 output of 75Ω, 1 V(p-p), is obtained from either terminal of the DC IN/SYNC or the VIDEO. The output is not developed simultaneously from both terminals.

⑦ **Top cover securing screws**

Remove 5 securing screws, and remove the top cover to set switches and to adjust volume inside the camera.

## 5. CONNECTION

### 5.1 When Using AC Adaptor

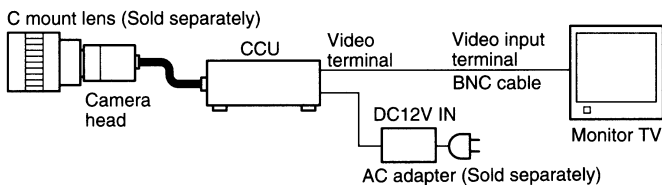

### 5.2 When Using 12 Pin Connector

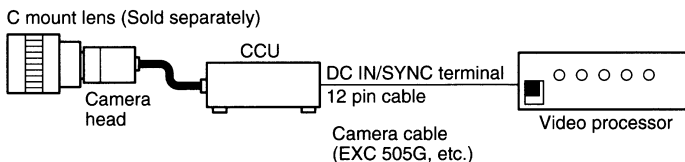

\* For pin layout of 12 pin connector, see Page 10. When making a cable, use a connector equivalent to HIROSE DENKI connector (HR10A-10P-12S(01)).

#### Important:

A matching label is provided on each camera head and controller. If heads and controllers are mismatched performance cannot be guaranteed. Always use units with the same matching label.

- For DC power (12V), an optional AC adaptor AC-M412W is recommended. When using any other power supply, make sure it meet the following specifications:

Output voltage:	DC12V $\pm$ 10%
Current capacity:	Higher than 0.4A, less than 1.0A
Ripple voltage:	Less than 50 mV (p-p)
Connector:	DC input connector (Hirose Denki HR10A-7P-4S) Pins 1, 2: $\oplus$ , pins 3, 4: $\ominus$

- Applicable lens

When using a special mount lens (M19 pitch 0.5), the mounting threads or any protrusion from the rear of the lens should be less than 4 mm in length. When using a C-mount lens, the length should be less than 6.5 mm.

#### Important:

When the weight of the lens exceeds 300g, mount the camera head by the lens. This camera has no adjustment mechanisms for back focus.

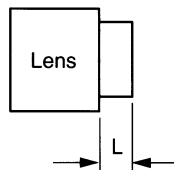



# 6. I/O SIGNALS

## 6.1 External Sync Signal

- 1. HD      $3.0 \pm 1.5 \text{ V}$  (p-p) negative polarity,  $75 \Omega$  unbalanced
- 2. VD      $3.0 \pm 1.5 \text{ V}$  (p-p) negative polarity,  $75 \Omega$  unbalanced

• External sync frequency should be within  $\pm 1\%$  from H sync frequency.

**Important:**

Input pulse specifications are as follows:

- 1. HD      $6.0 \mu\text{s} \sim 10.0 \mu\text{s}$
- 2. VD      $3\text{H} \sim 9\text{H}$

## 6.2 Trigger Input

- 1. Pulse level                      Low level: less than 0.5V, High level: 4-5V
- 2. Edge timing:                    TTL:    Rising Edge  
    OPT:    Falling Edge
- 3. Input interface (S202)

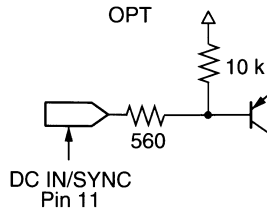
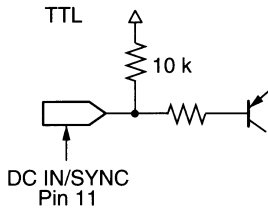

**Important**

Width of the input trigger is as follows:  
 $5 \mu\text{s} \leq \text{trigger width} \leq 1\text{ms}$

## 6.3 12 Pin Connector DC IN/SYNC Terminal

To use the DC IN/SYNC terminal, use following connections.

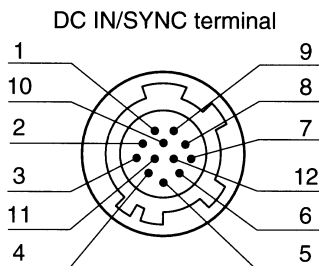

Pin Number	Ext. sync mode	Internal Sync Mode
	HD,VD	
1	GND	GND
2	+12V	+12V
3	VIDEO 1 (GND)	VIDEO 1 (GND)
4	VIDEO 1 (Signal)	VIDEO 1 (Signal)
5	HD input (GND)	–
6	HD input (Signal)	–
7	VD input (Signal)	–
8	VIDEO 2 (GND)	VIDEO 2 (GND)
9	VIDEO 2 (Signal)	VIDEO 2 (Signal)
10	VIDEO INDEX	VIDEO INDEX
11	TRIGGER IN	TRIGGER IN (Signal)
12	VD input (GND)	TRIGGER IN (GND)

\* VIDEO 1 output is obtained at VIDEO terminal or DC IN/SYNC (pin 4) terminal, and VIDEO 2 output at DC IN/SYNC (pin 9) terminal.

- In 1/30I and 1/30N modes, the video output is developed at VIDEO 1.  
In 1/60N mode, the odd and even video outputs are alternately developed at VIDEO 1 and VIDEO 2.

### Important:

VIDEO 1 output is developed at either terminal of the VIDEO or the DC IN/SYNC.  
In 1/30I and 1/30N modes, the VIDEO 2 output is not used as a video signal output.

## 7. ELECTRONIC SHUTTER SETTING METHOD

The electronic shutter switch number corresponds to the shutter speeds shown in the table below.

Switch Position	0	1	2	3	4	5	6	7
Shutter speed Position (sec)	$\frac{1}{60}$	$\frac{1}{100}$	$\frac{1}{125}$	$\frac{1}{250}$	$\frac{1}{500}$	$\frac{1}{1000}$	$\frac{1}{1500}$	$\frac{1}{2000}$

Switch Position	8	9	A	B	C	D	E	F
Shutter speed Position (sec)	$\frac{1}{3000}$	$\frac{1}{4000}$	$\frac{1}{6000}$	$\frac{1}{8000}$	$\frac{1}{10000}$	$\frac{1}{30000}$	$\frac{1}{50000}$	(Note 1)

\* In 1/30 second shutter speed, set the switch position to "0" and turn S201<sup>Ⓒ</sup> "ON". (Available only when developing in 1/30I, normal mode.)

### Note 1:

- The position "F" is set at 2-pulse trigger.

## 8. VIDEO OUTPUT IN NORMAL MODE

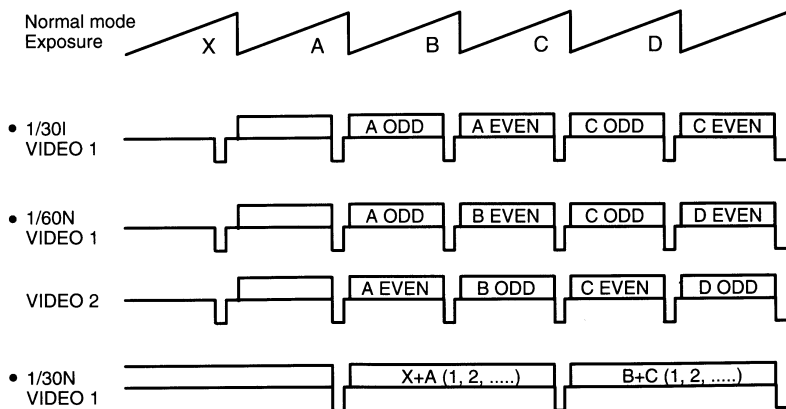

\* In 1/30I and 1/30N modes, the VIDEO terminal or pin 4 (VIDEO1) of DC IN/SYNC terminal can develop the VIDEO1 output. (Simultaneous output by using both terminals is not allowed.)

\* In 1/60N mode, the VIDEO terminal or pin 4 (VIDEO1) of DC IN/SYNC terminal can develop the VIDEO1 output. Pin 9 of DC IN/SYNC develops VIDEO2 output.

# 9. VIDEO OUTPUT IN 1-PULSE TRIGGER MODE (For setting, refer to page 18.)

This mode outputs one frame video image at arbitrary timing.

A SYNC reset mode which is reset by a V sync trigger, SYNC non reset mode which does not reset, and a TRIG-EXT. VD mode which allows arbitrary exposure time setting are provided.

## 9.1 1-Pulse Trigger SYNC Reset Mode

In this mode, the exposure begins with the trigger pulse, the exposure is carried out for the time set by the shutter speed, and the V sync is reset upon completion of the exposure. (Trigger polarity in TTL mode)

**Sync input conditions:**  
 Int. sync: available  
 Ext. sync: HD yes  
 VD no

- 1/30I mode (SELECT SW: 1/30I)

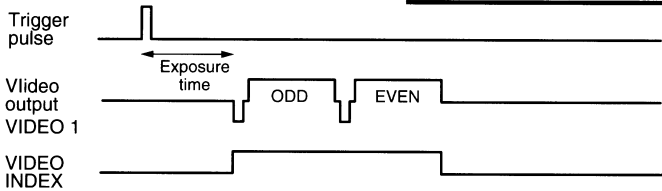

- 1/60N mode (SELECT SW: 1/60N)

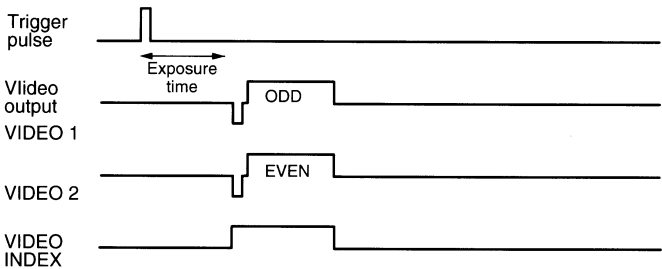

- 1/30N mode (SELECT SW: 1/30N)

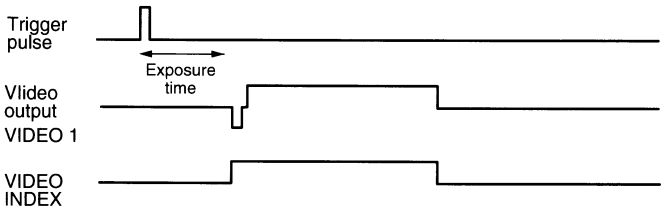

## 9.2 1-Pulse Trigger SYNC Non Reset Mode

In this mode, the exposure begins with the trigger pulse, the exposure is carried out for the time set by the shutter speed, the video signal is output at the first V sync after completion of the exposure (Trigger polarity in TTL mode).

### Sync input conditions:

Int. sync: available  
 Ext. sync: HD yes  
 VD yes

- 1/30I mode (SELECT SW: 1/30I)

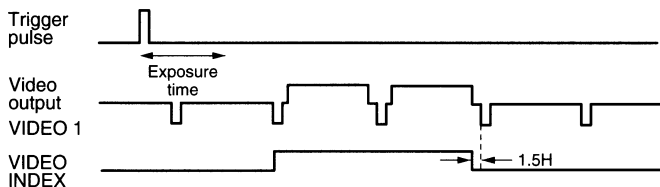

- 1/60N mode (SELECT SW: 1/60N)

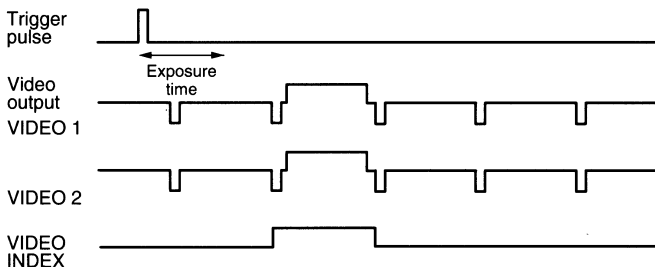

- 1/30N mode (SELECT SW: 1/30N)

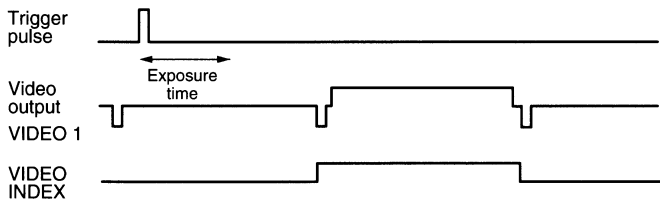

## 9.3 1-Pulse Trigger TRIG - EXT. VD Exposure Mode

In this mode, the exposure begins with the trigger pulse, and the exposure completes at trailing edge of the external sync VD input. The video signal is output at first V sync after completion of the exposure (Trigger polarity in TTL mode).

### Sync input conditions:

Int. sync: unavailable  
Ext. sync: HD yes  
VD yes

- 1/30I (SELECT SW: 1/30I)

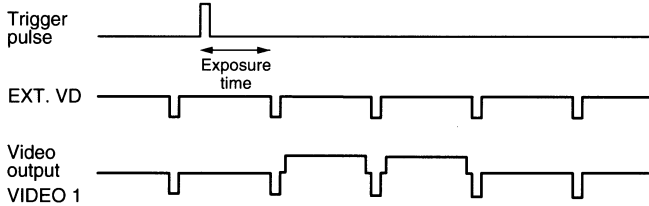

- 1/60N mode (SELECT SW: 1/60N)

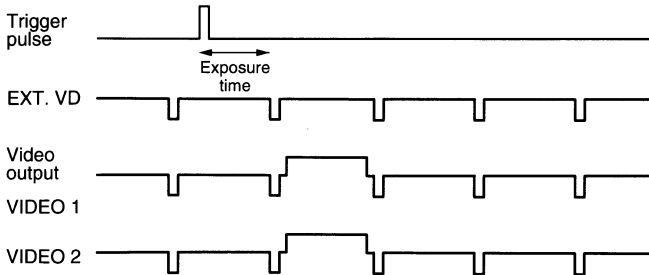

- 1/30N mode (SELECT SW: 1/30N)

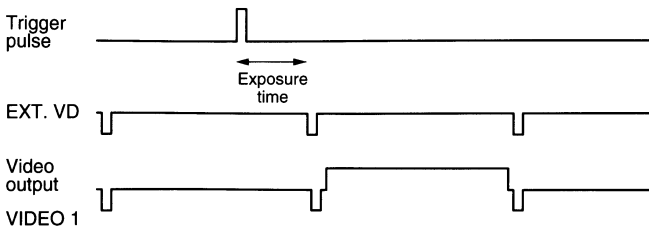

# 10. VIDEO OUTPUT IN 2-PULSE TRIGGER MODE (For setting, refer to page 18.)

This mode outputs one frame video image at arbitrary timing. The exposure time is determined by the width of 2 pulses.

A SYNC reset mode which is reset by a V sync trigger, and SYNC non reset mode which does not reset are provided.

## 10.1 2-Pulse Trigger SYNC Reset Mode

In this mode, the exposure begins with the trigger pulse, and ends with the next trigger pulse. At this time, the V sync is reset upon completion of the exposure. (Trigger polarity in TTL mode)

**Sync input conditions:**  
 Int. sync: available  
 Ext. sync: HD yes  
 VD no

- 1/30I mode (SELECT SW: 1/30I)

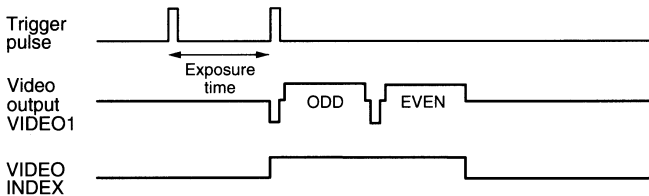

- 1/60N mode (SELECT SW: 1/60N)

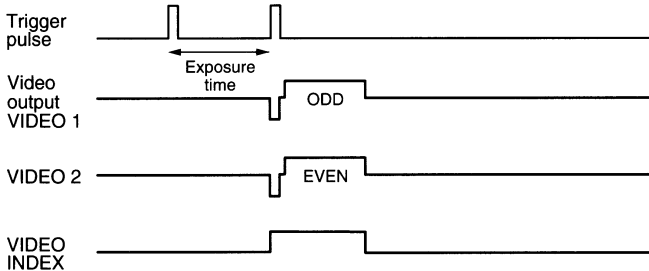

- 1/30N mode (SELECT SW: 1/30N)

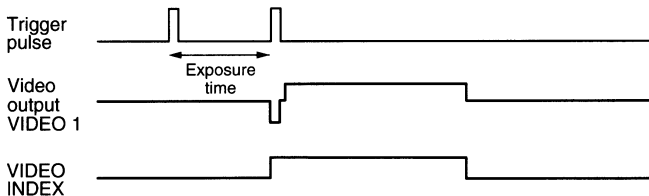

## 10.2 2-Pulse Trigger SYNC Non Reset Mode

In this mode, the exposure begins with the trigger pulse, and ends with the next trigger pulse. And, the video signal is developed at the first V sync after completion of the exposure (Trigger polarity in TTL mode).

### Sync input conditions:

Int. sync: available  
 Ext. sync: HD yes  
 VD yes

- 1/30I mode (SELECT SW: 1/30I)

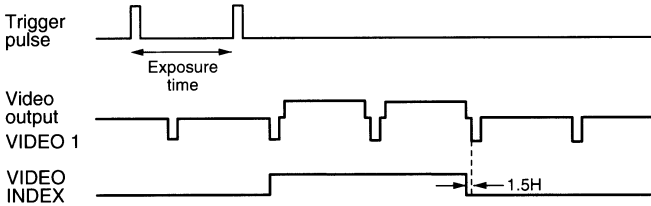

- 1/60N mode (SELECT SW: 1/60N)

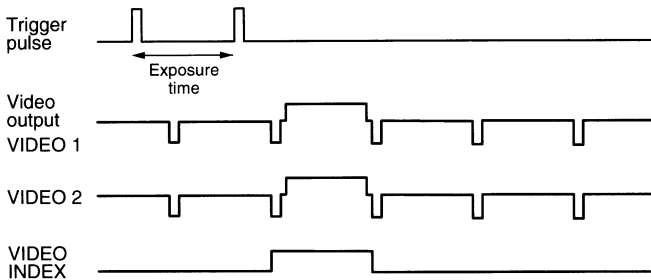

- 1/30N mode (SELECT SW: 1/30N)

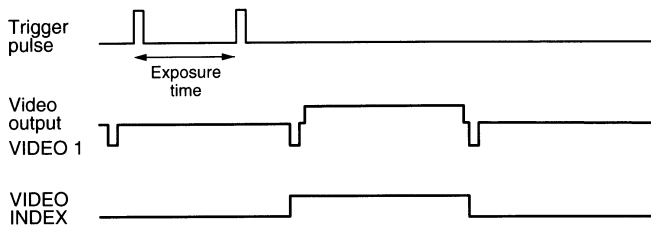



# 1 1. FREEZE MODE

When the video signal output is developed in 1/30I, 1-field still image is obtained with the freeze switch (S201⑤) "ON" in 1-pulse trigger SYNC non reset mode or 2-pulse trigger SYNC non reset mode.

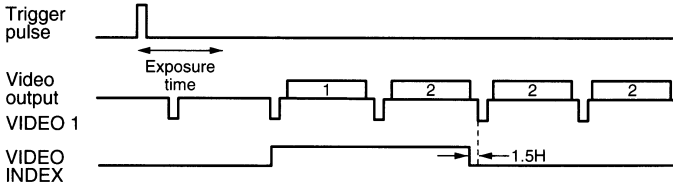

# 12. LOCATION AND FUNCTION OF INTERNAL SWITCHES

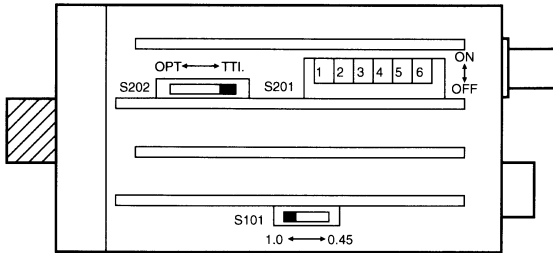

Location diagram of the CCU internal switches

Name	Function	Location
S201①~④	1-pulse / 2-pulse trigger mode setting	Refer to the Table 1.
S201⑤	Freeze (Note 1)	ON
S201⑥	Low speed (1/30 second) shutter (Note 2)	ON
S202	Trigger input impedance switch	TTL OPT
S101	Gamma correction switch	1.0 0.45

**Note 1:** This is available only when the video signal is developed in 1/30I of either 1-pulse trigger SYNC non reset mode or 2-pulse trigger SYNC non reset mode.

**Note 2:** This is available only when the video signal is developed in 1/30I of the normal mode with the electrical shutter switch set to "0".

**Important:** When changing the switch setting, always turn off the power, and use an insulated screw driver, etc.

**Table 1 Normal mode and trigger mode switch position**

S201 ①	S201 ②	S201 ③	S201 ④	Electronic shutter SW	Operation description
OFF	OFF	OFF	OFF	0~E	Normal mode
OFF	OFF	ON	ON	0~E	1-pulse trigger SYNC non reset mode
OFF	ON	ON	ON	0~E	1-pulse trigger SYNC reset mode
ON	ON	ON	ON	E	1-pulse trigger TRIG ~ EXT. VD mode
OFF	OFF	ON	ON	F	2-pulse trigger SYNC non reset mode
OFF	ON	ON	ON	F	2-pulse trigger SYNC reset mode

## 13. GAIN SWITCH

GAIN SW	GAIN	Remark
OFF	0dB	
ON	0~+9dB	Adjustable by using the volume (RV15) inside the CCU.

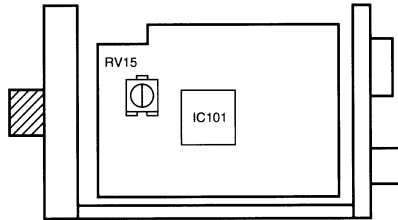

**Location diagram of the CCU internal GAIN volume (RV15)**

**Important**

When turning the volume, always use an insulated screwdriver, etc.

**Figure 1 Output waveform timing chart (H)**

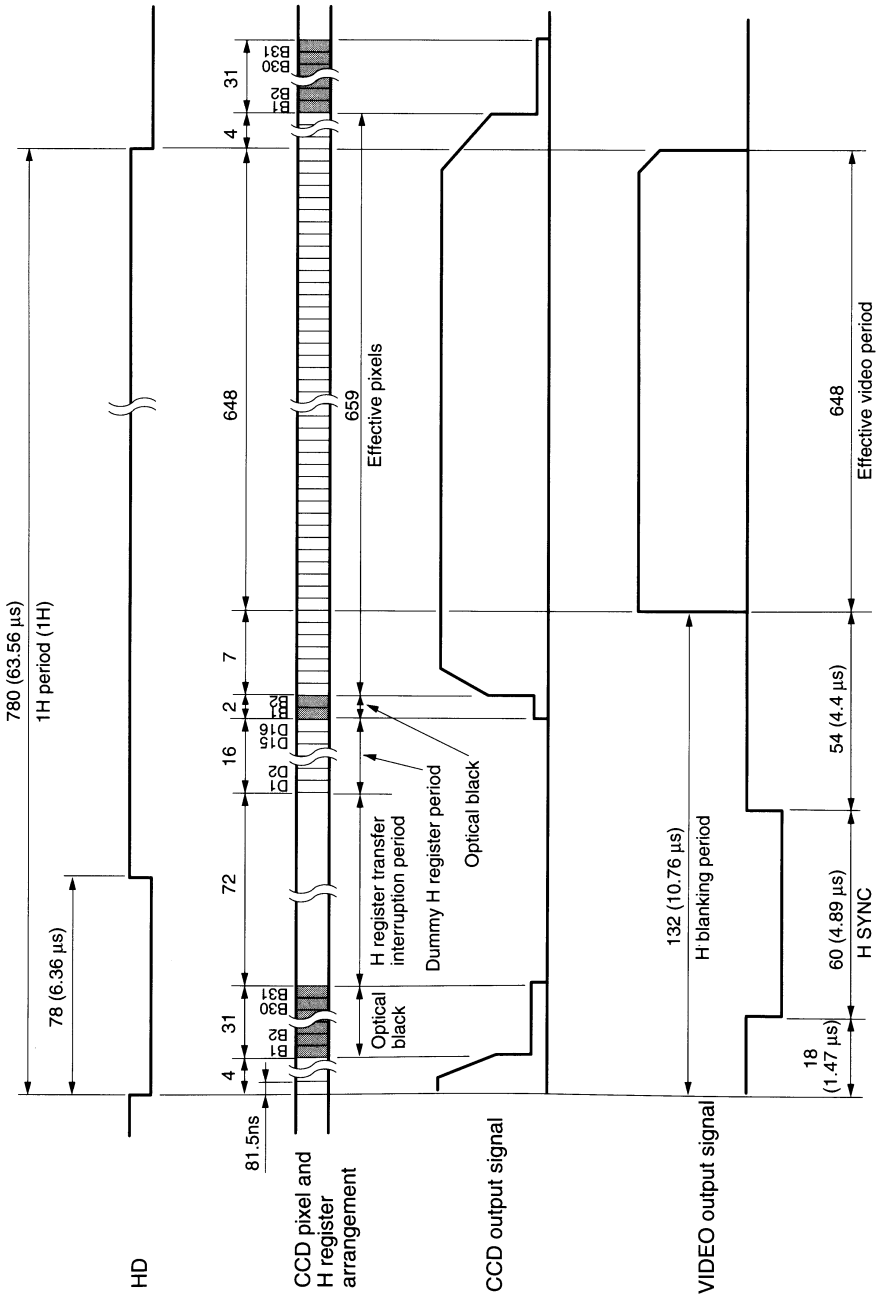
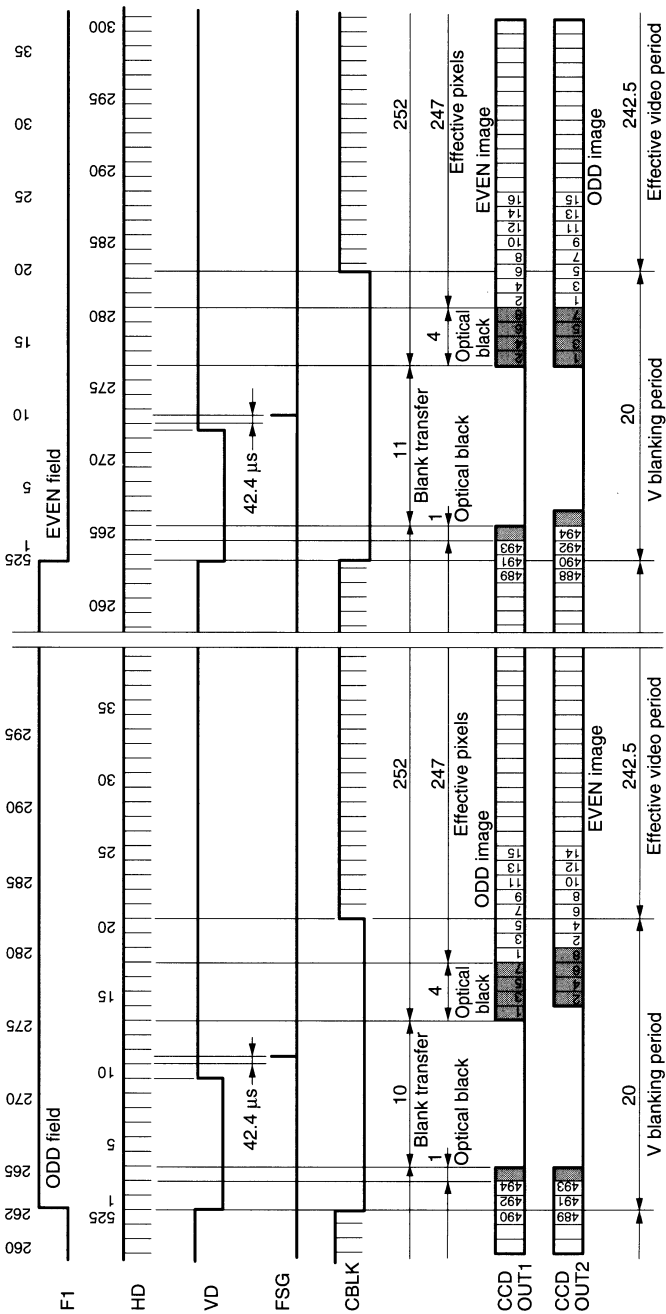
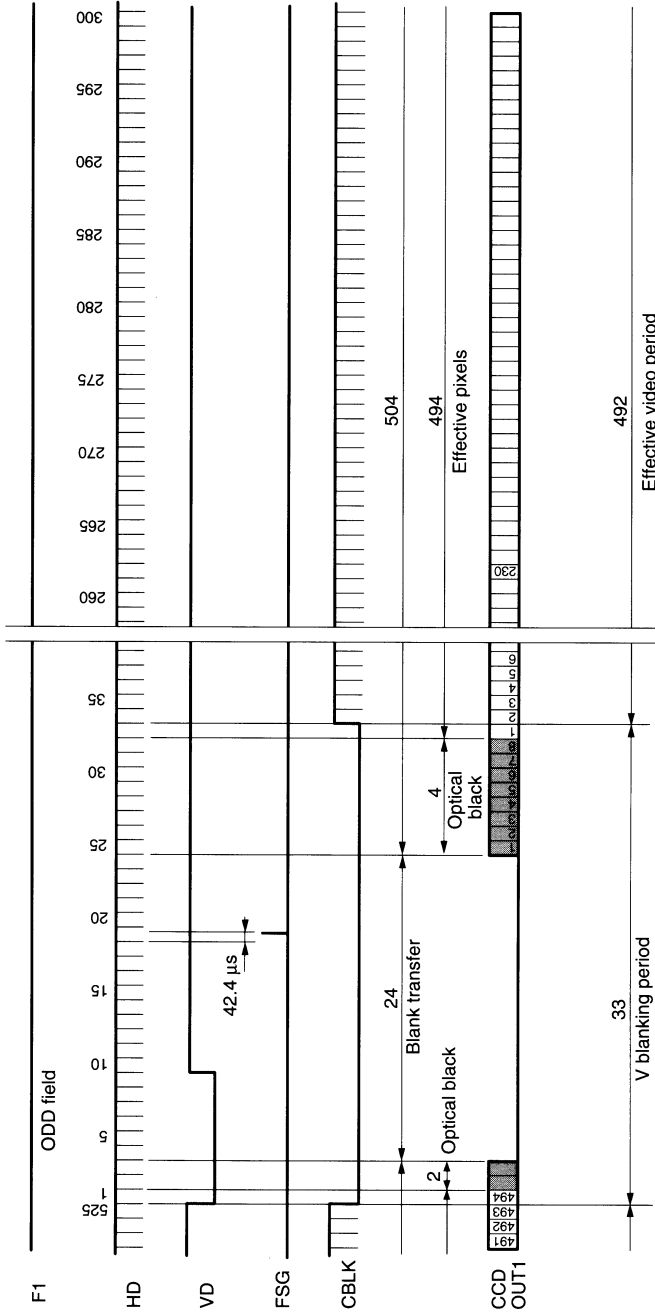

Figure 2-1 1/60N and 1/30I output waveform timing chart (V)



**Figure 2-2 1/30N output waveform timing chart (V)**



# 14. CHANGING HEAD CABLE ORIENTATION

The output direction of the camera cable on the camera head can be changed from left back (factory setting viewed in front of) to left side. Changing the output direction will change wiring conditions inside the camera head, so be careful. Changing to right back or right side is also possible, but consult with the service shop or service personnel in this case.

## (A) Output direction changing from left back to left side

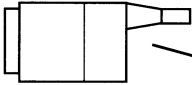
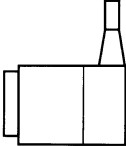
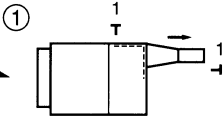
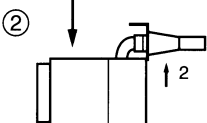
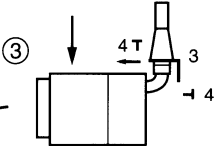
Changing from left back to left side	Procedures	Description on procedures
 <p>Pull out in left back direction</p>  <p>Pull out in left side direction</p>	 <p>①</p>  <p>②</p>  <p>③</p> <p>4 T</p>	<p>①</p> <p>1. Remove 2 screws (1 at back side, 1 at front side)</p> <p>②</p> <p>2. Pull out cable bushing in side direction (take care not to damage internal wiring leads).</p> <p>③</p> <p>3. Insert cable bushing from back side (take care not to jam the cable).</p> <p>4. Tighten the screws firmly.</p>

### Note:

- Take care not to apply tension and torque to the wiring material inside the camera head and the flexible PC board, it may cause break down of the wiring leads or damage the camera head.

**Consult with the service shop or authorized personnel**

The following will change wiring conditions inside the camera head. We recommend you to use the service shop or authorized service personnel.

**(B) Changing from left side to right side**

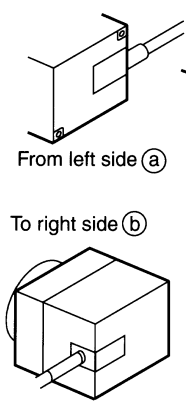
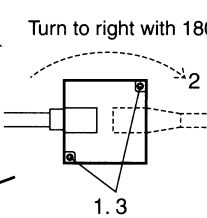
Changing from left side to right side	Procedures	Description on procedures
 <p>From left side (a)</p> <p>To right side (b)</p>	 <p>Turn to right with 180°</p> <p>1. 3</p> <p>2</p>	<ol style="list-style-type: none"><li>1. Remove 2 securing screws on the back panel.</li><li>2. Pull out flexible PC board from back panel, and rotate entire back panel by 180° in clockwise direction (take care not to break wiring leads).</li><li>3. Restore flexible PC board on back panel again and firmly tighten 2 screws.</li></ol>

**Cautions:**

- Take care not to apply tension and torque exceeding 180° to the wiring material, because this may change wiring conditions inside the unit. Also take care not to twist the flexible PC board. If twisted, it may cause break down of wiring leads or damage circuits inside the camera head
- (A) and (B) will be made in combination as required.

# 15. CAUTIONS ON USE AND INSTALLATION

- **Carefully handle the units.**  
Do not drop or give a strong shock or vibration to the camera. This may cause problems. Treat the camera cables carefully to prevent cable problems such as cable breakdown and loosened connections.
- **Do not shoot intense light.**  
If there is an intense light at a location on the screen such as a spot light, blooming and smearing may occur.  
Do not aim the camera at the sun. If an intense light enters, vertical stripes may appear on the screen.
- **Lens treatment.**  
Do not look at the sun through the lens.
- **Handling of the camera head and protection cover.**  
Keep the camera head and the protection cover away from children. Children may put them into mouth or swallow them accidentally. The protection cover protects the image sensing plane when the lens is removed from the camera head, do not throw away.
- **Do not touch internal parts.**  
Tampering with the internal parts may cause operation failure or injury.
- **Operating ambient temperature and humidity.**  
Do not use the camera in places where temperature and humidity exceed the specifications. Picture quality will degrade and internal parts may be damaged.
- **Do not splash water.**  
Install the camera in a location free from water splash. If splashed, turn off the camera power switch and stop supplying power, then consult with your dealer.
- **Install the camera in a location free from noise.**  
If the camera or the cables are located near power utility lines or a TV, etc. undesirable noise may appear on the screen. In such a case, try to change the location of the camera or the cable wiring.
- **When not using the camera for a long-time.**  
Turn off the camera power switch and stop supplying power.
- **Should you notice any trouble.**  
If an abnormality occurs such as no picture obtained, turn the camera power switch off and stop supplying power, then consult with the dealer. Using the camera without checking the cause of the trouble may lead to further damage or unexpected accident.
- **When cleaning the camera**  
Always turn off the power and make a cleaning with a piece of dry cloth. If necessary, gently wipe with a cloth dampened with thinned detergent. Do not use benzine, alcohol, thinner, etc. If used, coating and printed letters may be discolored. When cleaning the lens, use a lens cleaning paper, etc.

# 16. BEFORE MAKING A SERVICE CALL

Symptom	Items to be checked
No picture	<ul style="list-style-type: none"><li>• Is the power supplied correctly?</li><li>• Is the lens iris adjusted correctly?</li><li>• Are the cables connected correctly?</li><li>• Is the monitor (TV) adjusted correctly?</li><li>• Is the mode switch set correctly?</li><li>• No picture is displayed with no trigger input in 1 pulse trigger / 2 pulse trigger modes.</li></ul>
Poor color	<ul style="list-style-type: none"><li>• Is the lens iris set correctly?</li><li>• Is the shutter speed set correctly? Or, is the video signal developed from both terminals of VIDEO and DC IN/SYNC? (The video signal should be developed from either of terminal.)</li></ul>
No external sync.	<ul style="list-style-type: none"><li>• Is the mode switch set correctly?</li><li>• Is the external sync pulse entered with correct phase and amplitude?</li><li>• Is the external input pulse entered in the accuracy within the frequency pull-in range?</li></ul>